

# Nucleic Acid (Throughput-12) Automatic Extraction System

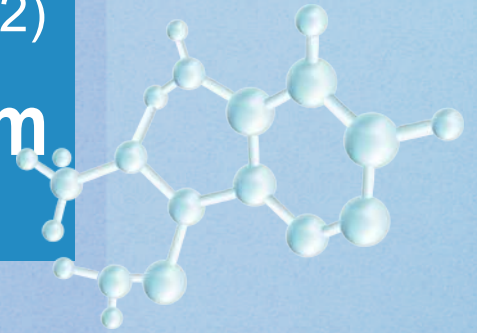

Economical  
and flexible  
Compact size

Strong  
magnetic force  
Avoid cross  
contamination

Auxiliary drying  
Open system

Multiple modes  
Precise temperature  
control

Easy operation  
Short operation  
time



# Nucleic Acid Automatic Extraction System (Throughput-12)



**Product introduction:** With the latest isolation method of nucleic acid transferred by magnetic rods and preloaded magnetic beads-based extraction reagent, The YC701 Nucleic Acid Automatic Extraction System can process 1-12 samples and automatically isolate nucleic acids from various samples such as blood, cells, viruses, etc. The magnetic beads are adsorbed, transferred and released by the special magnetic rod, so as to realize the fully automated purification of nucleic acid.

## [Product Features]



### **Economical and flexible:**

The design of single reagent strip allows free control of throughput and avoids reagent waste.



### **Compact size:**

It can be easily placed in a biosafety cabinet to process biologically hazardous samples. 350\*250\*380mm (L×W×H)



### **Strong magnetic force:**

High-performance magnetic rod ensure magnetic bead s recovery rate ≥98%.



### **Avoid cross contamination:**

UV sterilization module effectively reduce the cross contamination between wells.



### **Auxiliary drying:**

Separate drying well can be heated to shorten waiting time and reduce the probability of cross contamination.



### **Open system:**

Applicable to various magnetic beads-based extraction reagents.



### **Multiple modes:**

Pre-programmed multiple protocols for different samples.



### **Precise temperature control:**

Automatic heating for lysis and elution, with fast heating speed and precise temperature control.



### **Easy operation:**

7-inch touchable color screen to meet the needs of intelligent and convenient operation.



### **Short processing time:**

Up to 12 samples can be processed in 25-35min.

# Nucleic Acid Automatic Extraction System (Throughput-12)



## [Unique Magnetic Rod Movement]

The driving device is equipped with a high-performance stepping motor, with large magnetic rod vibration amplitude. The vibration amplitude can be set according to the volume of the solution to ensure good and even blending effect. The actuator is made of ball screw to ensure smoothly running, high precision and longer service life of the rod. Each moving component is protected by the limit position protection mechanism to avoid instrument failure.

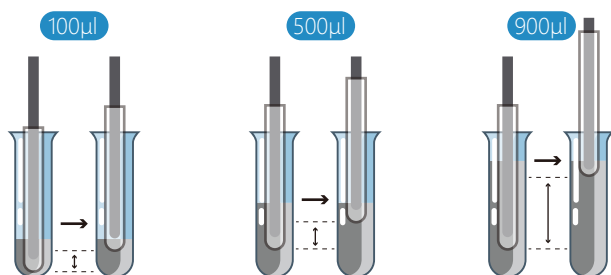

## [New Strong Magnetic rod]

With the newly designed strong magnetic rod, the magnetic beads are absorbed on the head of the magnetic rod, so as to ensure that the elution buffer can still cover all the magnetic beads even with a small elution volume. The high recovery of magnetic beads ensures high yield of nucleic acid.

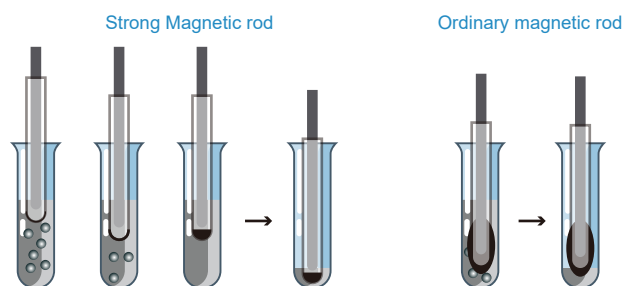

## [Working principle]

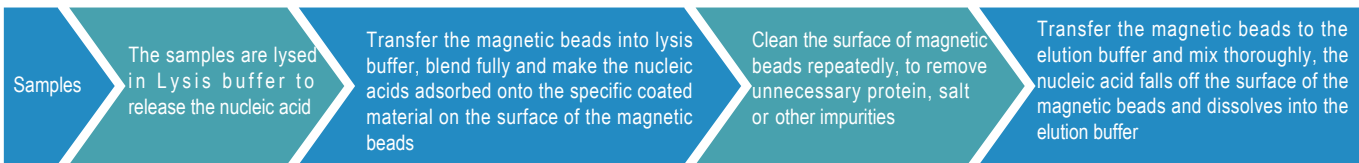
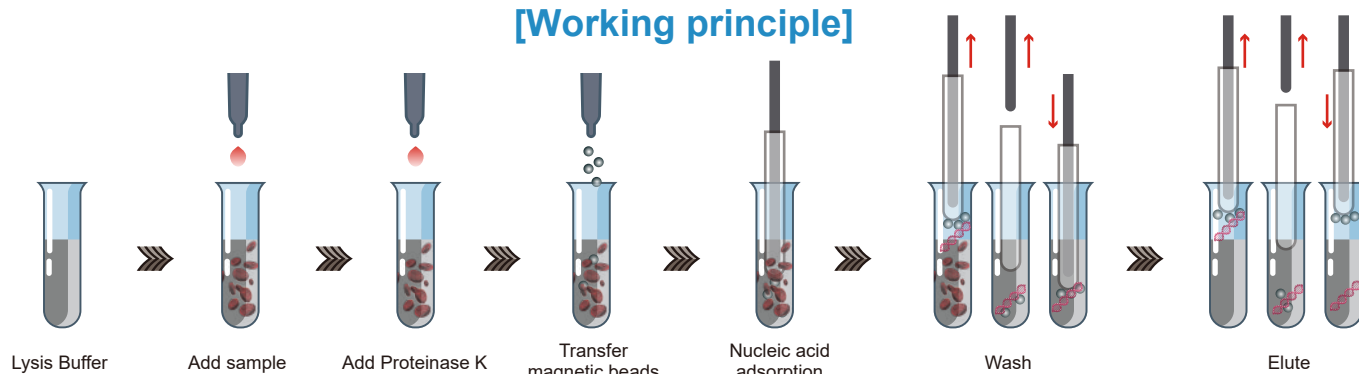

## [Instrument parameters ]

Product name	Nucleic Acid Automatic Extraction System	Nucleic acid extraction purity	1.8≤OD260/OD280≤2.0
Model	YC701	Inter-well purification variation	CV<3%
Certification	CE/RoHS	Magnetic beads recovery	≥98%
Throughput	12 samples per run	Screen size	7-inch touchable color screen
Consumables	8-well reagent tube + magnetic rod sleeve	Disinfection/decontamination method	UV lamp, fan
Nucleic acid extraction time	25-35 minutes	Input power	AC 100-240V~, 3.5-1.8A, 50/60Hz
Temperature control precision	0.5°C	Product weight	17±1kg
Temperature control accuracy	±1.5°C	Product size	350*250*380mm (L×W×H)
Heating range	Ambient temperature ~ 100°C		

## [Product Introduction]



This kit is suitable for TECHSTAR YC701 Nucleic Acid Automatic Extraction System for extracting genomic DNA/RNA of pathogenic microorganisms from samples such as serum, plasma, cultured cells, saliva, alveolar lavage fluid, nasopharyngeal aspirates and swabs.

### [Product name]

Magnetic Bead-Based Nucleic Acid (DNA/RNA) Extraction Kit

### [Product number]

SC902-50

### [Packing specification]

50 T/kit

### [Transportation condition]

Room temperature

### [Preservation condition]

Room temperature, or 2-8°C for long-term preservation

### [Period of validity]

12 months

### [Applicable instrument]

TECHSTAR YC701 Nucleic Acid Automatic Extraction System

## [Features]

01

With magnetic rod sleeve Preloaded in the reagent strip, which is automatically loaded and unloaded with the machine without manual operation.

02

Unique room temperature stable proteinase K, all reagents in the kit do not need to be stored at low temperature.

03

The magnetic beads optimized for the genomic DNA/RNA of pathogenic microorganisms have excellent adsorption effect on small fragments of nucleic acids.

04

With high repeatability and yield, it is able to recover trace amount of pathogenic microorganism genomic DNA/RNA.

### [Product components]

#### [Product components]

Product name	Qty.
Preloaded reagent strip	50 strips
Proteinase K	1 tube

#### [Product Dimensions]

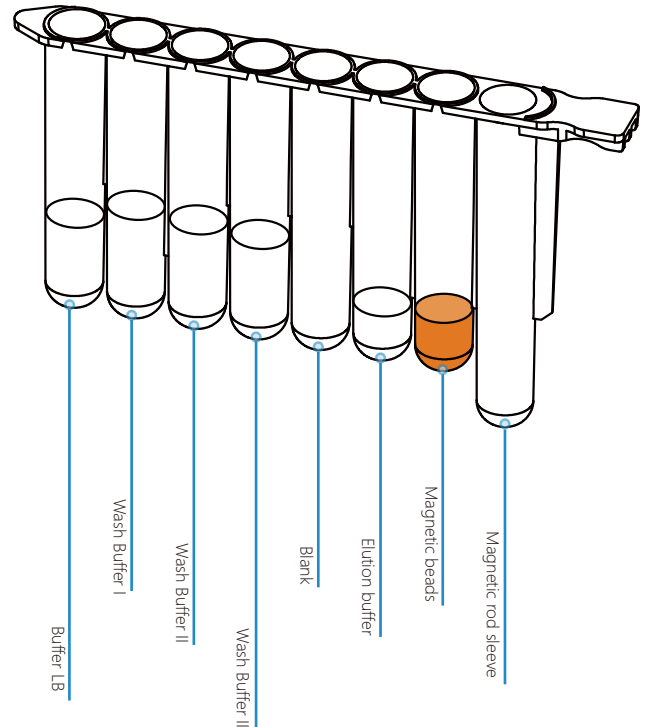
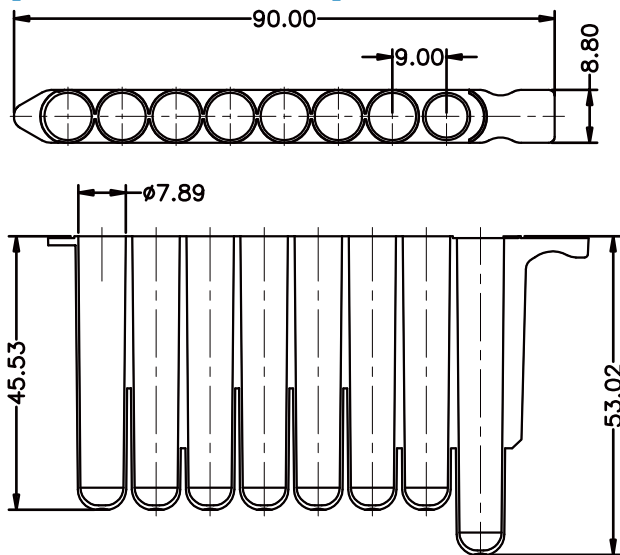

[Preloaded location of reagent]

### [Operation procedures]

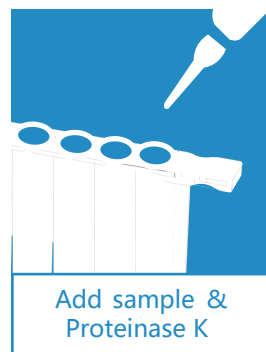
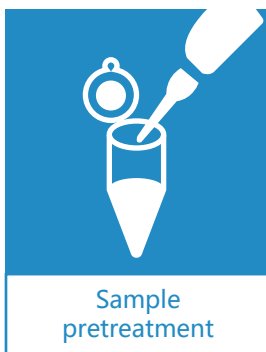



 **techstar** | Wuxi Techstar Technology Co.,Ltd.

 Meiyu Road No .117 Workshop No .2,  
Meicun Street ,Xinwu District ,Wuxi City ,  
Jiangsu Province, PRC

 +86-0510-6851 8058

 [www.tech-star.cn](http://www.tech-star.cn)

 [techstar8@163.com](mailto:techstar8@163.com)